

1

2

3

4

A

B

C

D

A

B

C

D

REVISIONS				
ZONE	REV	DESCRIPTION	DATE	APPROVED

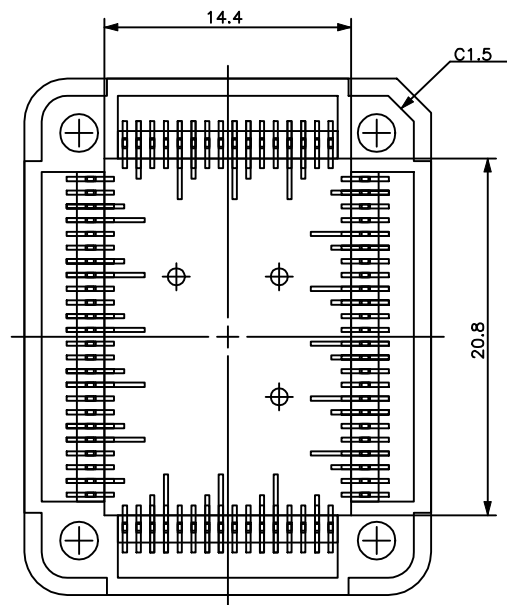
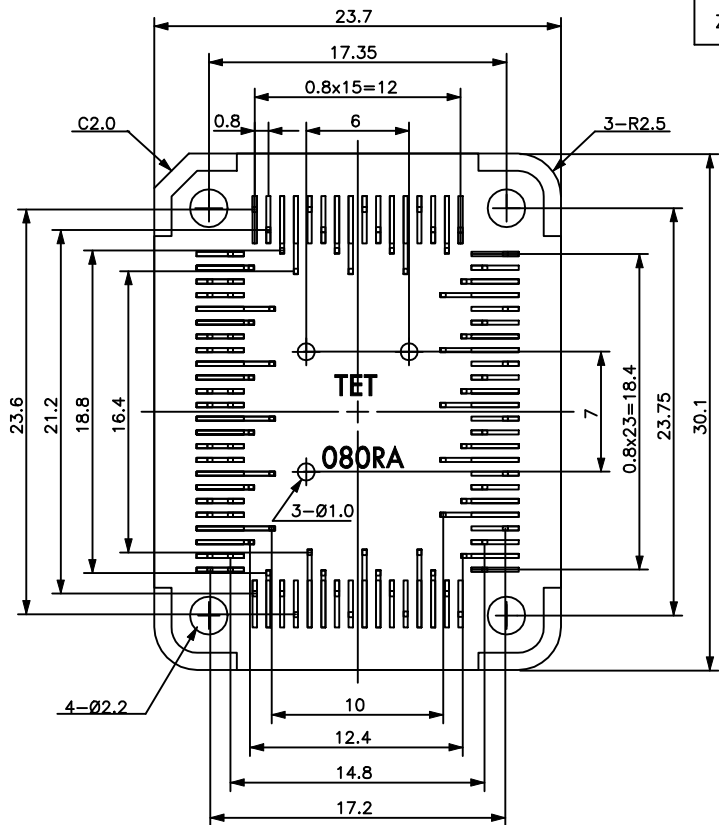

IC package	Rectangle
Pin count	80Pin
Lead pitch	0.8mm

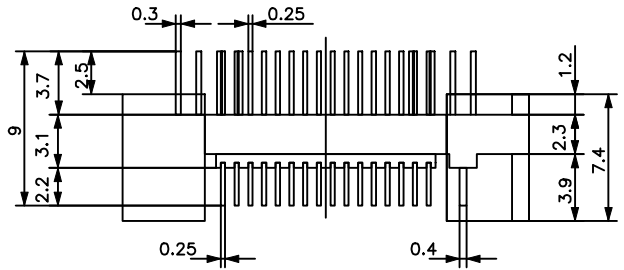

DRAWING NOT TO SCALE

ALL DIMENSIONS ARE IN MILLIMETERS

 www.adapters.com	adapters.com <i>An Embedded Systems Solutions Company</i>		
	DESCRIPTION: BASE-YQ-080Q8R-EM-CVR		
TEL:(408)855-8527 FAX:(408)855-8528 3024 Scott Blvd. Santa Clara, CA 95054	SIZE A	DATE: 12-11-01	PART NO. 000-2182-00
SCALE 1:1	CHECKED: Gabor Kardos	DRAWN BY: S. Barcellos	REV SHEET

1

2

3

4

Recommended a PWB layout of TQSOCKET/YQSOCKET080RA Series

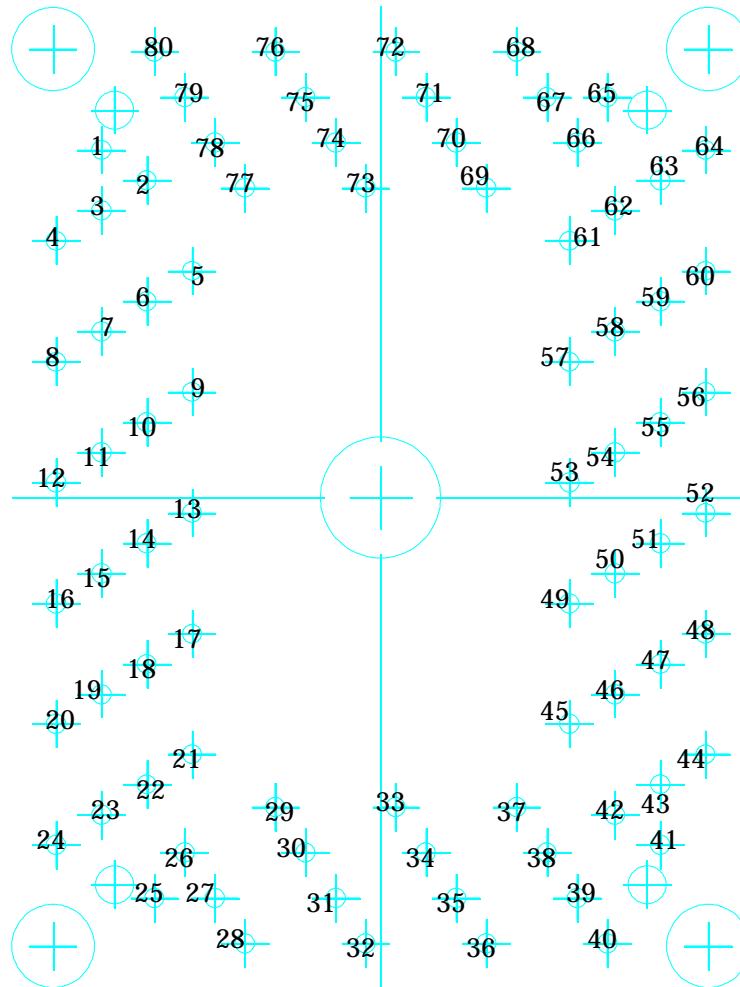

Eye Point

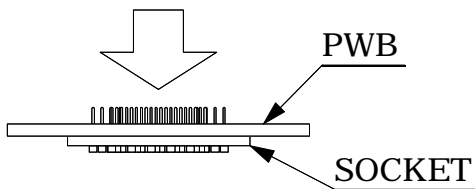

Part No.	TQ/YQSOCKET080RA	
IC package	Rectangle	
Pin count	80	
Unit : mm	Design : M.H	
TET TOKYO ELETECH CORP.		

Recommended a PWB layout of TQSOCKET/YQSOCKET080RA Series

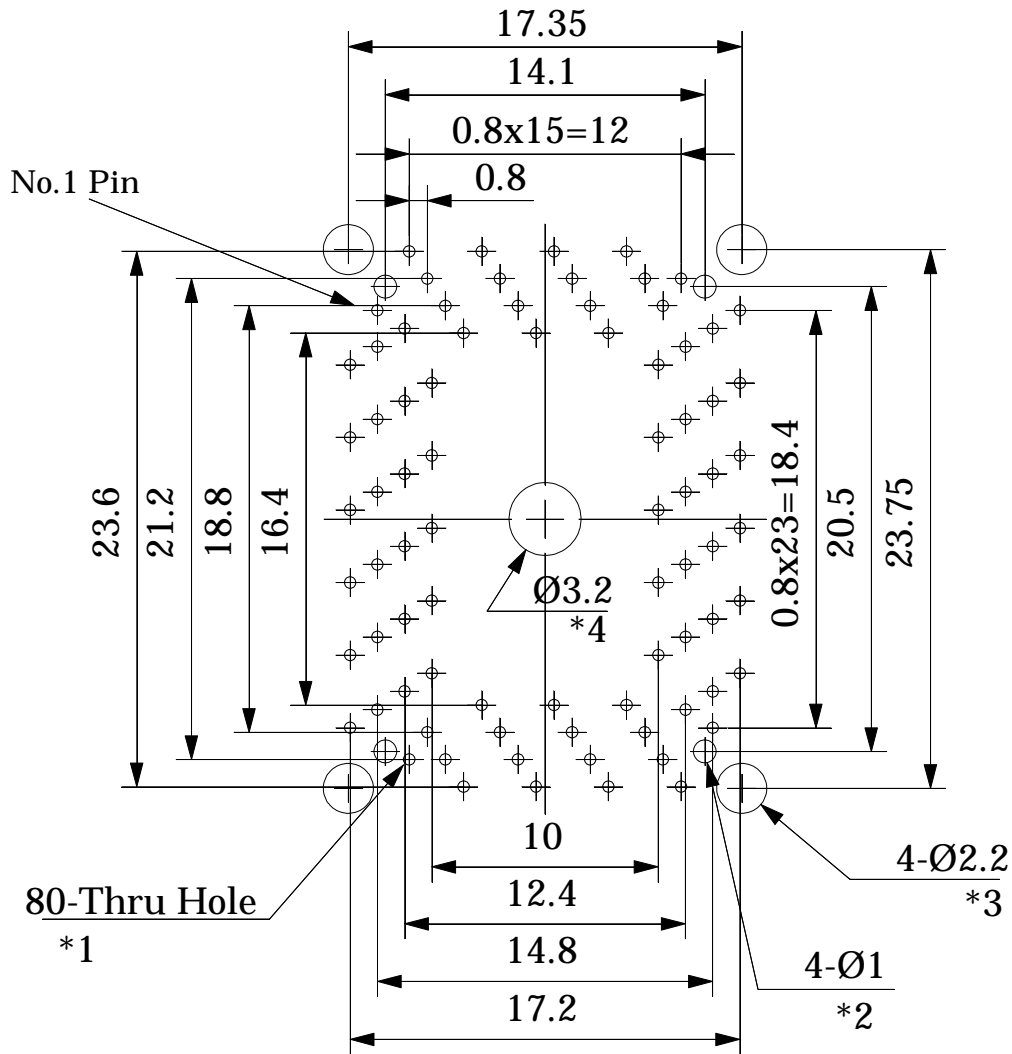

NOTES:

*1 \oplus mark is through hole.

The diameter is 0.5mm after plating copper on the hole.

*2 TQSOCKET guide pin hole and location.

*3 YQSOCKET guide pin hole and location.

*4 Screw hole and location for fastening TQSOCKET.

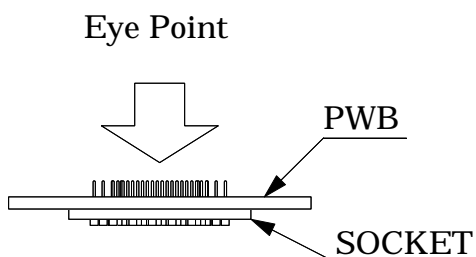

Part No.	TQ/YQ080RA	
IC package	Rectangle	
Pin count	80Pin	
Lead pitch	0.8mm	
Unit : mm	Design : M.H	
TET TOKYO ELETECH CORP.		