

1

2

3

4

A

A

B

B

C

C

D

D

REVISIONS				
ZONE	REV	DESCRIPTION	DATE	APPROVED

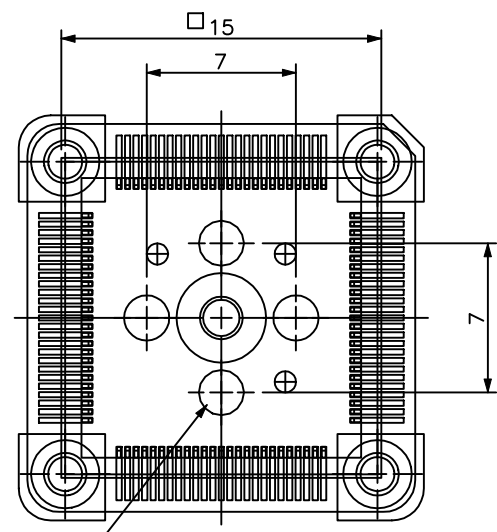
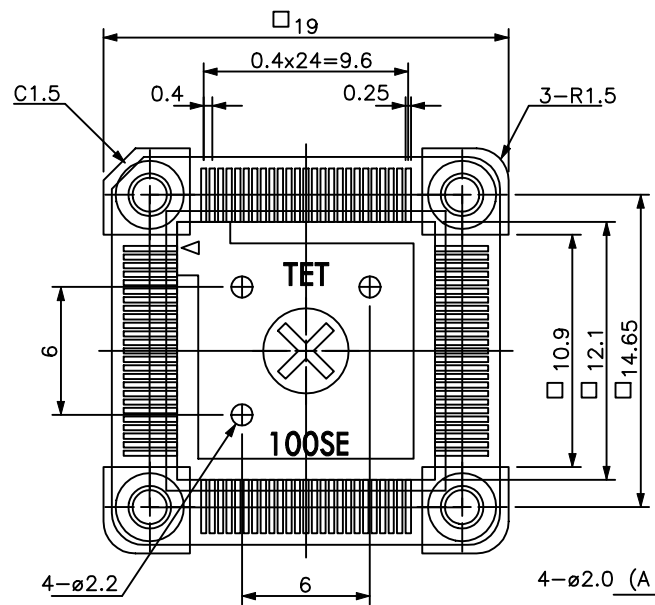

BOTTOM VIEW

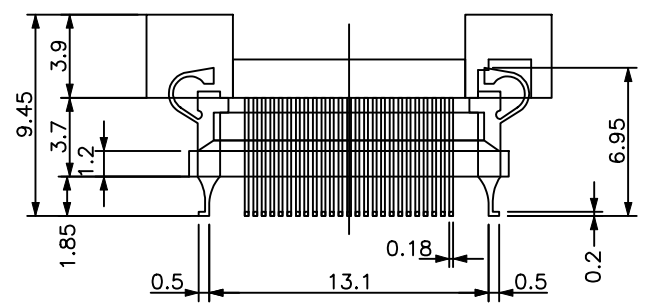

IC package	Square
Pin count	100Pin
Lead pitch	0.4mm

DRAWING NOT TO SCALE

ALL DIMENSIONS ARE IN MILLIMETERS

 www.adapters.com	adapters.com <i>An Embedded Systems Solutions Company</i>		
	DESCRIPTION: BASE-NQ-100Q4-SMT		
TEL:(408)855-8527 FAX:(408)855-8528 3024 Scott Blvd. Santa Clara, CA 95054	SIZE A	DATE: 12-11-01	PART NO. 000-2220-00
SCALE 1:1	CHECKED: Gabor Kardos	DRAWN BY: S. Barcellos	REV SHEET

1

2

3

4

