

1

2

3

4

A

A

B

B

C

C

D

D

REVISIONS				
ZONE	REV	DESCRIPTION	DATE	APPROVED

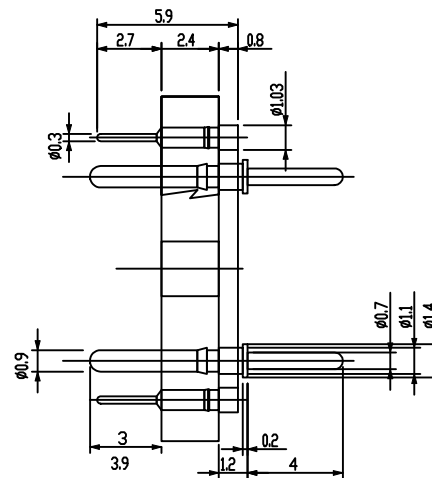
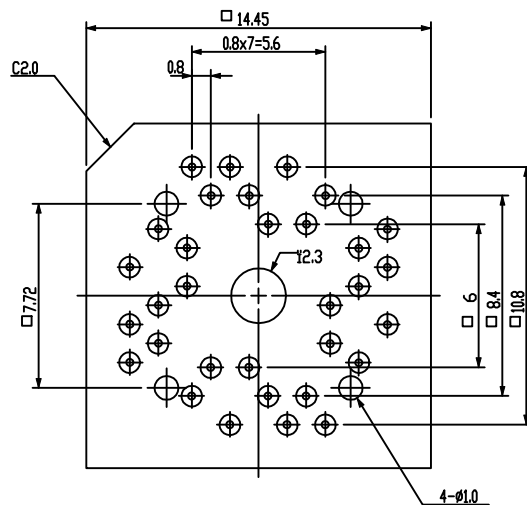

IC package	Square
Pin count	32 Pin
Lead pitch	0.80mm

ALL DIMENSIONS ARE IN MILLIMETERS

 www.adapters.com	An Embedded Systems Solutions Company		
	DO NOT SCALE DRAWING		
DESCRIPTION: RECEP-TQ-032Q8-3mmGP-FSTNR			
TEL:(408)855-8527 FAX:(408)855-8528	SIZE: A	DATE: 2-14-02	PART NO. 000-2653
3024 Scott Blvd. Santa Clara, CA 95054	SCALE 1:1	CHECKED: <i>Eabor Kardos</i>	DRAWN BY: <i>S. Barcellos</i> SHEET 1 of 1

1

2

3

4