

1

2

3

4

A

A

B

B

C

C

D

D

REVISIONS				
ZONE	REV	DESCRIPTION	DATE	APPROVED

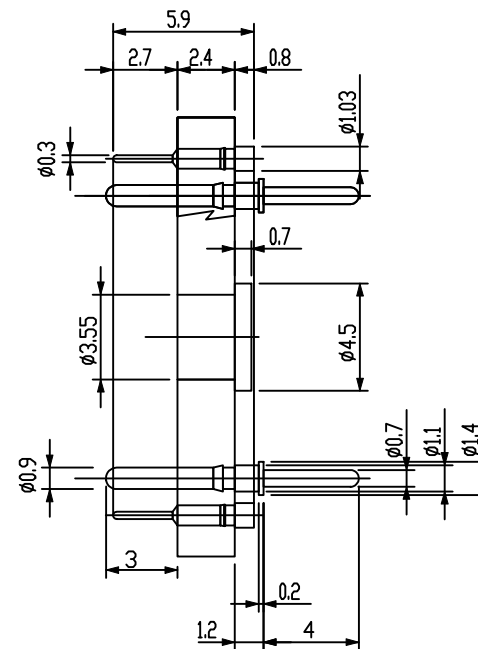
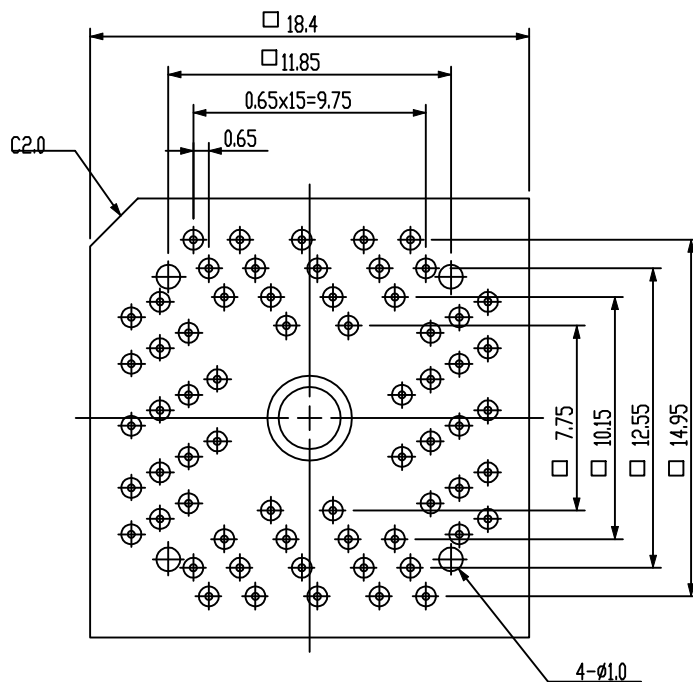

IC package	Square
Pin count	64 Pin
Lead pitch	0.65mm

ALL DIMENSIONS ARE IN MILLIMETERS

 www.adapters.com	An Embedded Systems Solutions Company		
	DO NOT SCALE DRAWING		
DESCRIPTION:	RECEP-TQ-064Q65-3mmGP-FSTNR		
TEL:(408)855-8527 FAX:(408)855-8528	SIZE: A	DATE: 2-15-02	PART NO. 000-2789
3024 Scott Blvd. Santa Clara, CA 95054	SCALE: 1:1	CHECKED: <i>Eabor Kardos</i>	DRAWN BY: <i>S. Barcellos</i>

REV

SHEET 1 of 1

1

2

3

4