

1

2

3

4

A

A

B

B

C

C

D

D

REVISIONS				
ZONE	REV	DESCRIPTION	DATE	APPROVED

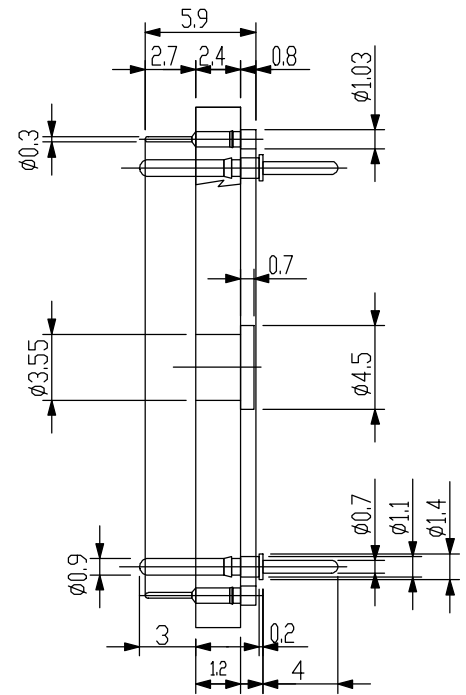
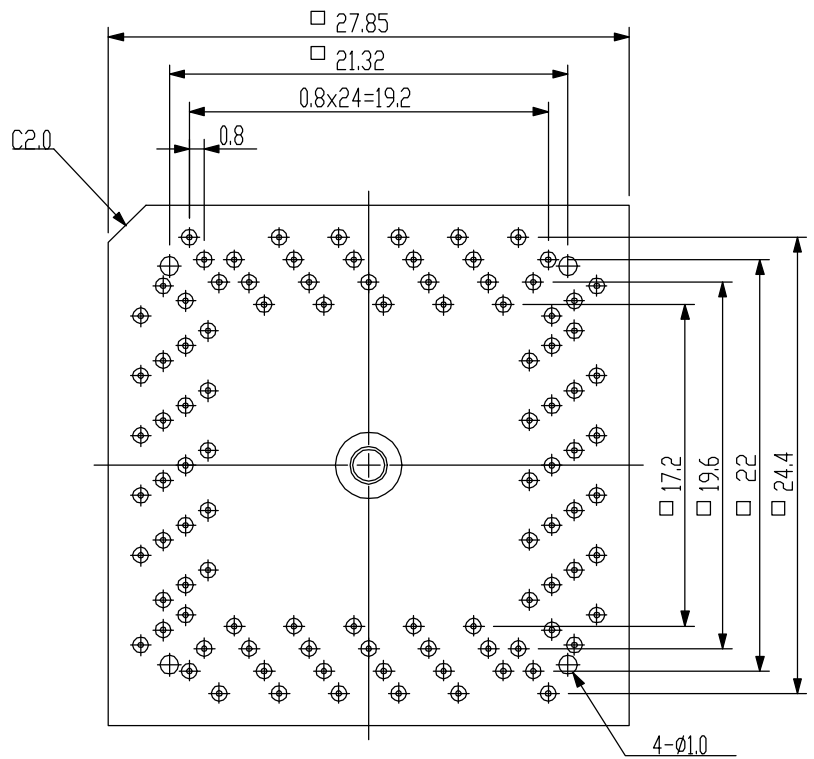

IC package	Square
Pin count	100 Pin
Lead pitch	0.80mm

ALL DIMENSIONS ARE IN MILLIMETERS

 www.adapters.com	<i>An Embedded Systems Solutions Company</i>		
	DO NOT SCALE DRAWING		
DESCRIPTION: RECEP-TQ-100Q8-3mmGP-FSTNR			
TEL:(408)855-8527 FAX:(408)855-8528 3024 Scott Blvd. Santa Clara, CA 95054	SIZE: A DATE: 5-6-02	PART NO.: 000-2953	REV:
SCALE: 1:1	CHECKED: <i>Eabor Kardos</i>	DRAWN BY: <i>S. Barcellos</i>	SHEET 1 of 1

1

2

3

4